

---

# Label Printer

---

***LPQ58***

***LPQ80***

***User Manual***

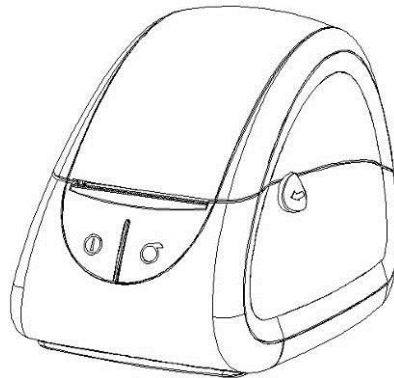

**Xiamen Hanin Electronic Technology Co.,Ltd**

Add: 5F,8#,Aide Airport Industrial Park,Huli

District,Xiamen,China 361009

Tel: +86-(0)592-588993

Fax: +86-(0)592-5885992

---



---

---

# Contents

<b>MANUAL INFORMATION .....</b>	<b>5</b>
<b>IMPORTANT SAFETY INSTRUCTIONS.....</b>	<b>6</b>
<b>CHAPTER1 INTRODUCTION.....</b>	<b>9</b>
1.1PACKING LIST.....	9
1.2 APPEARANCE AND COMPONENTS.....	10
1.3 DIMENSION .....	11
<b>CHAPTER 2 SPECIFICATION .....</b>	<b>13</b>
<b>CHAPTER 3 INSTALLATION &amp; USAGE .....</b>	<b>15</b>
3.1 MEDIA LOADING .....	15
3.2 POWER CONNECTION .....	17
3.3 INTERFACE CABLE CONNECTION.....	18
3.4 DETECTION.....	19
3.5 OPERATION PANEL.....	20
3.6 BASIC OPERATION.....	21
<b>CHAPTER 4 INTERFACE.....</b>	<b>22</b>
4.1USB INTERFACE .....	22
4.2 CASHDRAWER .....	22
4.3 SERIAL INTERFACE.....	23
<b>CHAPTER 5 CLEANING.....</b>	<b>24</b>
5.1 CLEANING MEDIA SENSOR.....	24
5.2 CLEANING THERMAL PRINT HEAD .....	24
5.3CLEANING ROLLER AND/OR PAPER PATH .....	24
<b>CHAPTER 6 LABEL PRINTER UTILITY INSTRUCTIONS.....</b>	<b>25</b>
6.1 INSTALLATION PREPARATION .....	25
6.2 USAGE.....	25
<b>CHAPTER 7 SEAGULL WINDOWS DRIVER INSTALLATION .....</b>	<b>32</b>
7.1 INTRODUCTION .....	32
7.2 INSTALLATION PREPARATION .....	32
7.3 INSTALLATION .....	33
<b>CHAPTER 8 BARTENDER® ULTRALITE INSTALLATION .....</b>	<b>38</b>
8.1 INTRODUCTION .....	38
8.2 INSTALLATION PREPARATION .....	38
8.3 INSTALLATION .....	39

---

---

---

## ■ Statement

This manual content may be altered without permission, and Xiamen Hanin Electronic Technology Co., Ltd. reserves the rights to make changes without notice in technology, spare parts, hardware and software of the products. If more information is needed about the products, please contact Xiamen Hanin Electronic Technology Co., Ltd. Without any written permission from the company, any section of this manual is prohibited to be copied or transferred in any form.

## ■ Copyright

This manual is printed in 2016, the copyright belongs to Xiamen Hanin Electronic Technology Co. Ltd.

Printed in China

1.5 Version

## ■ Warnings



This must be complied with in order to avoid any damage to the human body and the equipment.



This is showing the important information and tips for the printer operation.

***Due to continuous update of our product, the description of printer specification, accessories, design in this manual may slightly different, please in kind prevail.***

---

# Manual Information

This *User Manual* contains basic information for product usage as well as for emergency measures that may be required.

Provides information on utility usage for function selection, operating condition modification etc.

Provides information on Seagull Windows Driver installation.

Provides information on BarTender® UltraLite installation.

※ Following separate manual provide more detailed content on various technological issues and areas.

## **1.Programming Manual**

This manual provides information on label printer commands.

# Important Safety Instructions

Before using the present appliance, please carefully read the following safety regulations in order to prevent any hazard or material damage.

## 1. Safety Warning



Warning: The print head will become very hot during printing, avoid contact with the print head after printing has finished.



Warnings: Do not touch the printer head and connector in case static damage the printer head.

## 2. Instructions



Warnings: Violating following instructions can cause serious injury or death.

- 1) Do not plug several products in one multi-outlet.
  - This can provoke over-heating and a fire.
  - If the plug is wet or dirty, dry or wipe it before usage.
  - If the plug does not fit perfectly with the outlet, do not plug in.
  - Be sure to use only standardized multi-outlets.
- 2) You must use only the supplied adapter.
  - It is dangerous to use other adapters.
- 3) Do not pull the cable to unplug.
  - This can damage the cable, which is the origin of a fire or a breakdown of the printer.
- 4) Do not plug in or unplug with your wet hands .
  - You can be electrocuted.
- 5) Do not bend the cable by force or leave it under any heavy object.
  - A damaged cable can cause a fire.



Caution: Violating following instructions can cause slight wound or damage the appliance.

- 1) If you observe a strange smoke, odour or noise from the printer, unplug it before taking following measures.
  - Switch off the printer and unplug the set from the mains.
  - After the disappearance of the smoke, call your dealer to repair it.
- 2) Install the printer on the stable surface.
  - If the printer falls down, it can be broken and you can hurt yourself.
- 3) Use only approved accessories and do not try to disassemble, repair or remodel it for yourself.
  - Call your dealer when you need these services.
  - Do not touch the blade of auto cutter.
- 4) Do not let water or other foreign objects drop into the printer.
  - If this happened, switch off and unplug the printer before calling your dealer.
- 5) Do not use the printer when it is out of order. This can cause a fire or an electrocution.
  - Switch off and unplug the printer before calling your dealer.
- 6) Other considerations:
  - Place the printer on a solid and even base so that it cannot fall.
  - Leave enough space around printer for operation and maintenance.
  - Keep all liquids away from the printer.
  - Do not expose the printer to high temperatures, direct sunlight or dust.
  - Ensure the printer is connected to a socket with the correct mains voltage.
  - Switch off the printer POWER supply when it's not in use for a long time.
  - To ensure the printing quality and reliability, suggest use the same quality or recommend paper supplier.
  - Pls. switch off the POWER supply when connect/disconnect all the ports or it will cause damage to the printer control circuit.
  - Never carry out maintenance or repair work yourself. Always contact a qualified service technician.
  - Keep this User Manual in a place which is easily accessible at all times.

### 3. Other Precautions

The copyright for this user manual and various other manuals is property of the HPRT Corporation. Any copying or conversion into electronic form and saving of this material without the express written permission of HPRT Corporation. is strictly prohibited. Use of the information contained in this manual is not subject to any patent liability. This manual has been prepared with utmost care and attention to detail but may contain certain errors and/or omissions. HPRT Corporation. is not legally liable for any damages resulting from the use of the information in this manual. HPRT Corporation. and its affiliates are not legally liable (United States excluded) for any damages, loss, costs, and/or expenses that result from the breakdown, malfunction, and/or misuse of the product due to violation or neglect of the operation and maintenance information and instructions provided by the HPRT Corporation., as well as from the unauthorized alteration, repair, and/or modification of the product by the user and/or third party. HPRT Corporation. is not legally liable for any damages and/or issues resulting from the use of options and/or parts that are not authentic HPRT products or authorized products.

### 4. WEEE (Waste Electrical and Electric Equipment)



This mark shown on the product or its literature indicates that the corresponding item should not be discarded at the end of its working life with other household waste. To prevent possible harm to the environment or human health from uncontrolled waste disposal, please separate marked items from other types of waste and recycle them responsibly to promote the sustained reuse of material resources. Household users should contact either the retailer where they purchased this product, or their local government office for details of where and how they can conduct environmentally safe recycling of such items. Commercial users should contact their suppliers and check the terms and conditions of purchase contracts. This product should not be combined with other commercial waste for disposal.



**Caution: This is a Class A product. In a domestic environment this product may cause radio interference in which case the user may be required to take adequate measures.**



# Chapter1 Introduction

## 1.1 Packing List



**Notes:**

1. Unpack the printer and keep the packing material in case you need to ship the printer in the future.
2. Make sure you own all parts as follows, if not, do contact the seller.

### ■ Standard Accessories



Printer



Quick Start Guide



Power Adapter

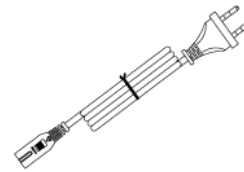

Power Cord



Cables Fastener



### ■ Optional Accessories



USB Cable



Serial Cable



Paper Roll



CD

**Note:** The type of power cord varies by local or region.

## 1.2 Appearance and Components

### ■ Front

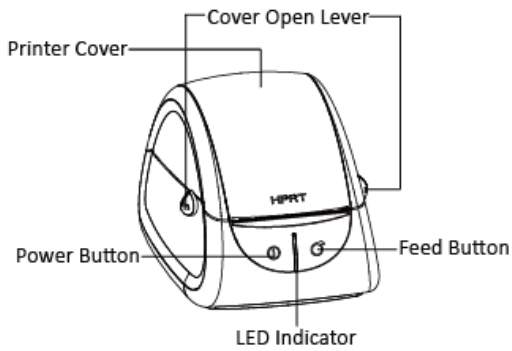

### ■ Rear

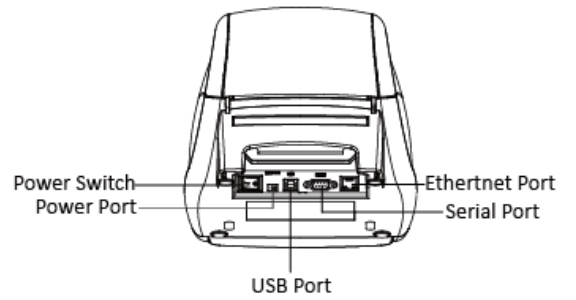

### ■ Inside

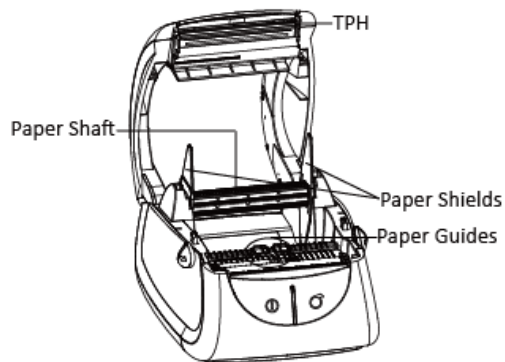

### ■ Install the cables fastener



### 1.3 Dimension

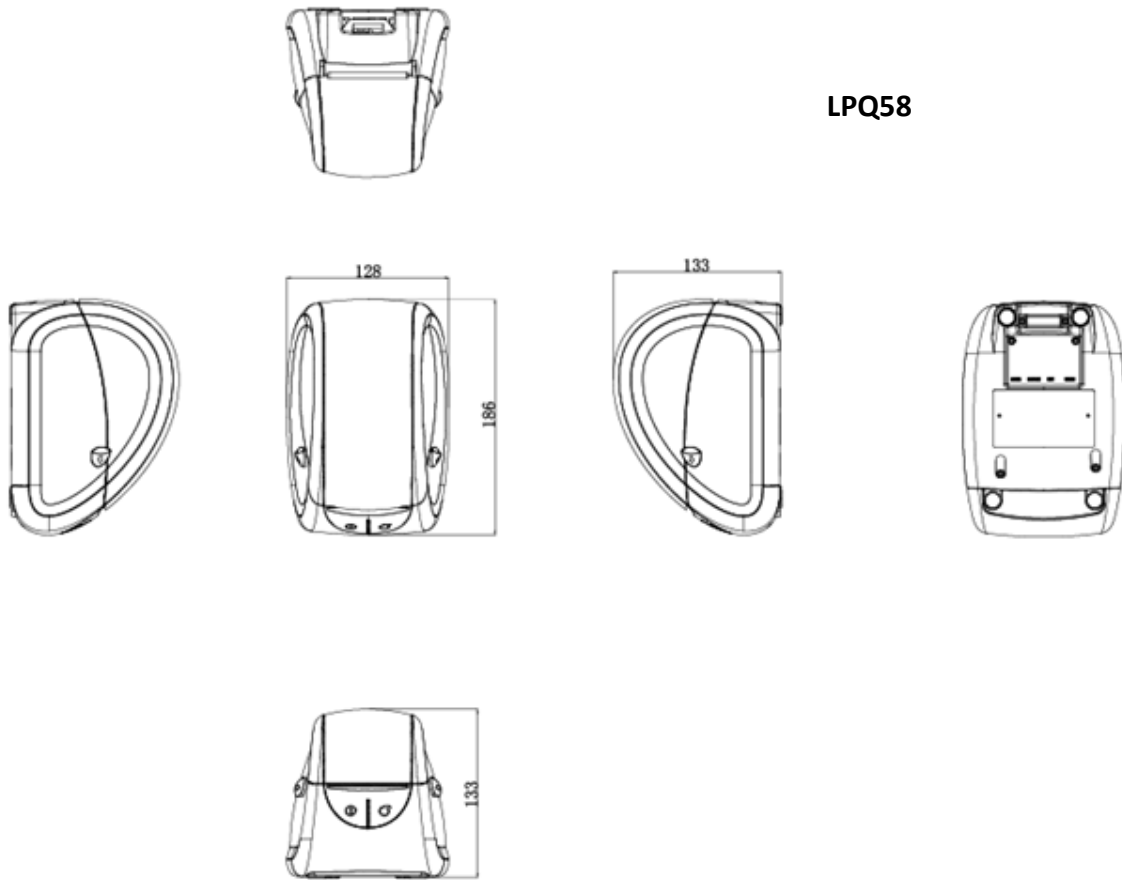

LPQ80

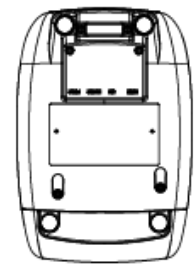
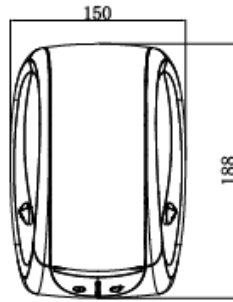
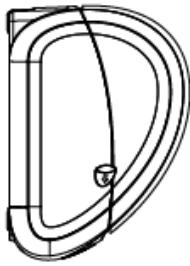

# Chapter 2 Specification

(2/1)

Items		Parameter	
		LPQ58	LPQ80
Printing	Printing Method	Direct Thermal Printing	
	Resolution	203dpi(8dots/mm)	
	Printing Speed	76mm/s Max.	102mm/s Max.
	Printing Width	56mm Max.	80mm Max.
	Printing Length	400mm	300mm
Processor		32 bit RISC CPU	
Memory	RAM	2MB	
	Flash	2MB	
Detection	Sensors	Out of Paper Detection, Gap Detection, Notch Detection, Black mark Detection, TPH Temperature Detection	
Media	Types	Fan-fed or Roll-fed, Die-cut or Continuous Label	
	Width	1''(25mm) – 2.44''(62mm)	1''(25mm) – 3.35''(85mm)
	Thickness	0.003''(76.2um) – 0.007''(177.8um)	
	Label Roll Diameter	90mm	
	Core Diameter	0.5''(12.7mm),1''(25.4mm),1.5''(38.1mm)	
Programming Language		TSPL	
Software	Label Design	Bartender® Ultralite	
	Seagull Driver	Windows 2000,XP,Vista,8,10	
Resident Fonts	Bitmap Fonts	6, 8, 12, 16, 32, OCR A & B. 90°, 180°, 270° rotatable and 10 times expandable in horizontal and vertical directions	
Code Pages		DOS437,720,737,755,775,850,852,855,856,857,858,860,862,863,864,865,866, Windows 1250,1251,1252,1253,1254,1255,1256,1257,1258 ISO8859-1,-2,-3,-4,-5,-6,-8,-9,-15 DBCS 932 (JIS), 936(GBK), 949 (Koran), 950(BIG5)	
Barcode	1D	Code 39, Code 93, EAN 8/13 (add on 2 & 5), UPC A/E (add on 2 & 5), I 2 of 5 & I 2 of 5 with Shipping Bearer Bars, Codabar, Code 128 (subset A, B, C), EAN 128, RPS 128, UCC 128, UCC/EAN-128 K-Mart, Random Weight, Post NET, ITF 14, China Postal Code, HIBC, MSI, Plessey, Telepen, FIM, GS1 DataBar, German Post Code, Planet 11 & 13 digit, Japanese Postnet, I 2 of 5 with human readable check digit, Standard 2 of 5, Industrial 2 of 5, Logmars, Code 11, Code 49, Cadablock	
	2D	PDF417, Data matrix code, Maxi Code, QR code, Micro PDF417, Micro QR code, Aztec code	
Interfaces		USB,RS232C	
Control Panel		Tri-color Status LED, Power and Feed button	

(2/2)

Items		Parameter	
		LPQ58	LPQ80
Power Adapter	Power Input	AC100V ~240V 50/60Hz 1.5A	
	Power Supply	DC12V 2A	
Environment	Operation	41°F -104°F (5°C -40°C),30% - 85% (non- condensing)	
	Storage	-4°F -122°F (-20°C -50°C),10%-50% (non- condensing)	
Physical Characteristics	Dimension(L*H*W)	186*133*128mm	188*134*150mm
	Weight	805g(excluding consumables)	880g(excluding consumables)
Options & Accessories		External label roll holder	
Agency Approvals		CCC,FCC,CE	

# Chapter 3 Installation & Usage

## 3.1 Media Loading

### 3.1.1 Paper Roll Loading

1. Use both of your index fingers to push the buttons towards front to open the top cover



2. Pull out the paper roll holder, 0.5/1.0/1.5 inch of core is accessible.

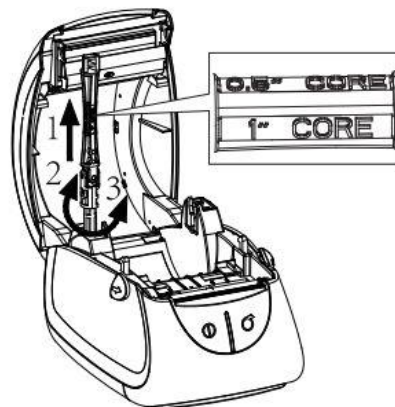

3. Insert the paper roll into the holder, and then lock the holder.

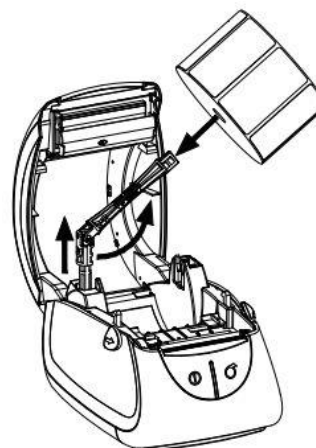

**Gap Sensor Note:** Please do center the sensor while not printing with black mark paper.

4. Pull some paper out, adjust the paper guide to fix the paper.

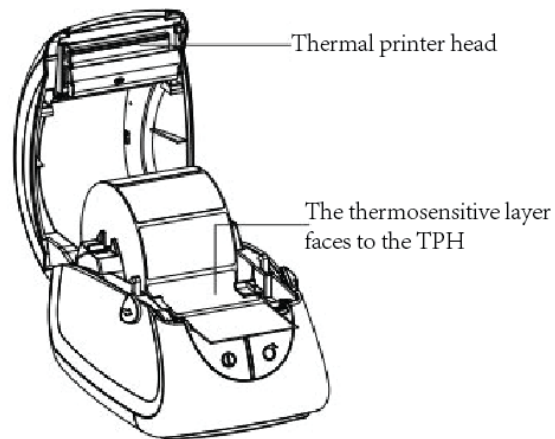

5. Close the cover and tear off the excess paper.

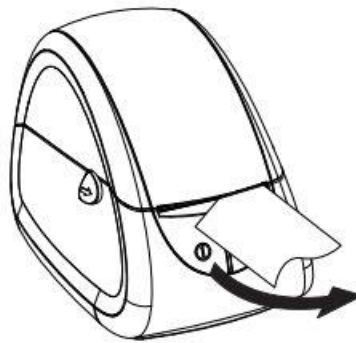



### 3.1.2 External Paper Roll

When you use external paper roll or big roll paper, please refer to the graph below to assemble the external roll mount and adjust the paper guide to fix the paper.

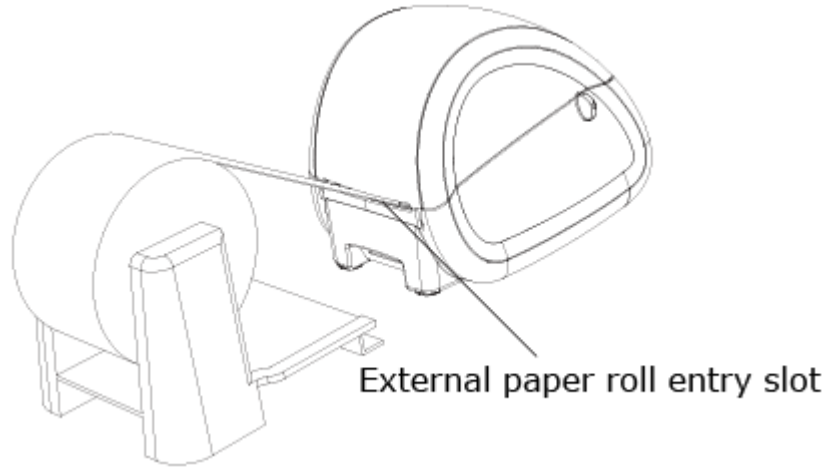

### 3.2 Power Connection

1. Make sure the printer is "Off".
2. Connect the AC adapter with power interface.
3. Connect the AC adapter with power cord.
4. Plug the other side of power cord into the socket outlet.

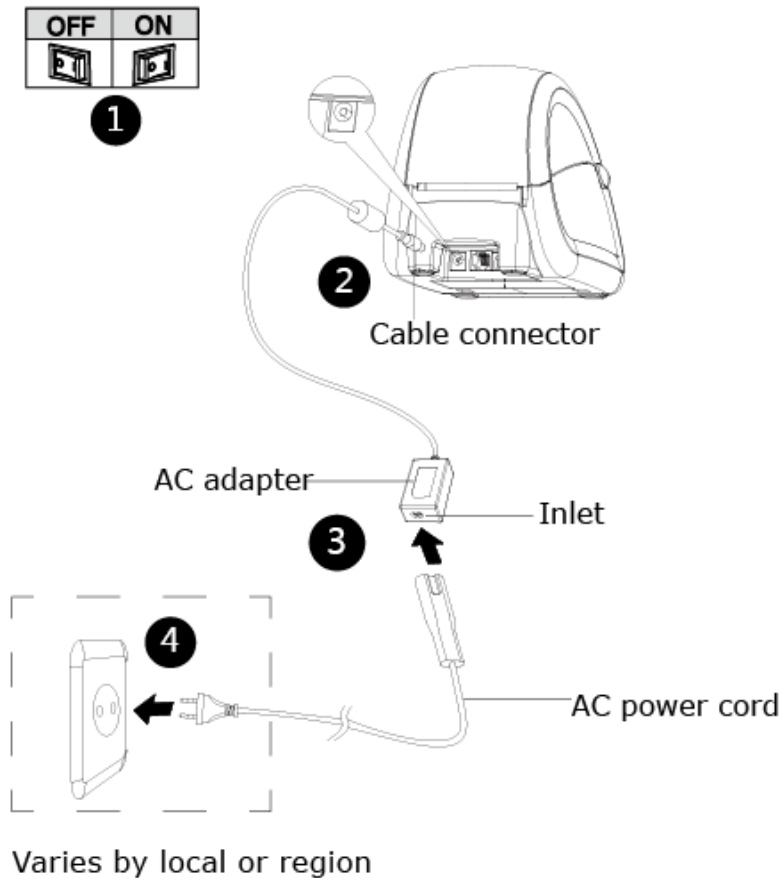

### 3.3 Interface Cable Connection

Connect the interface cable as shown below.

This printer supports the following communications interface standards.

- RS-232C(Serial) Cable
- USB B-Type Cable

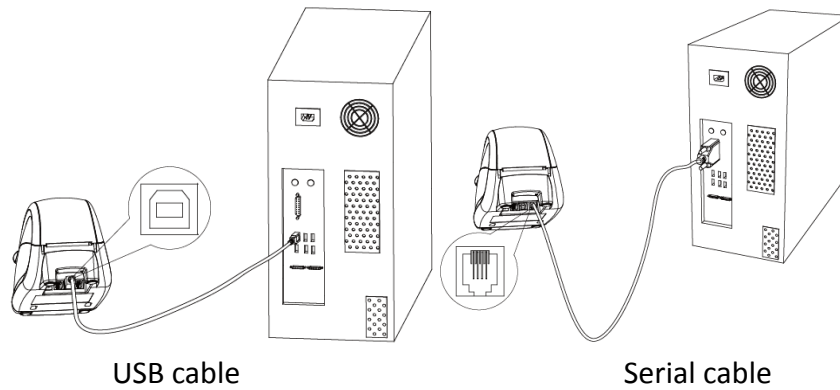

- 1) Turn off the power switch.
- 2) Connect the communication cable to the printer communication port to be used.
  - Connect the RS-232C(Serial) Cable to the serial port.
  - Connect USB B-Type cable to the USB port.

### 3.4 Detection

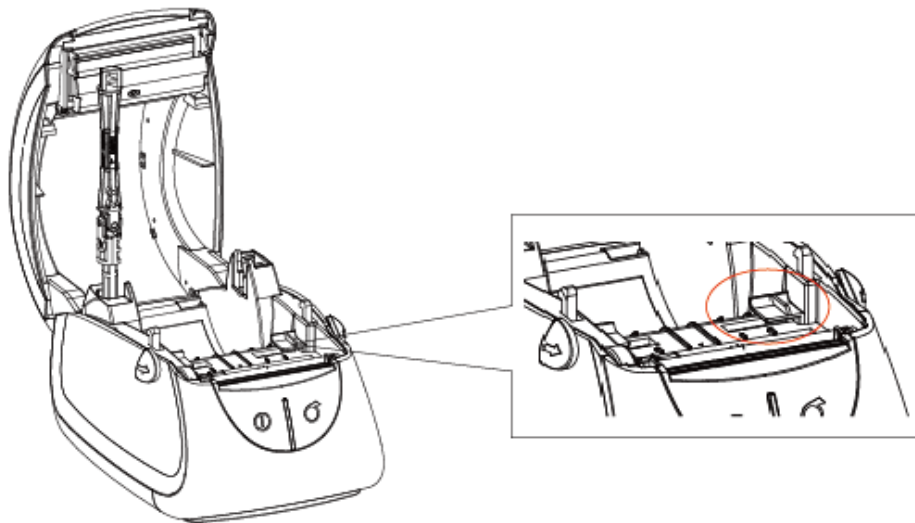

**Gap Sensor Note:** Please do center the sensor while not printing with black mark paper.

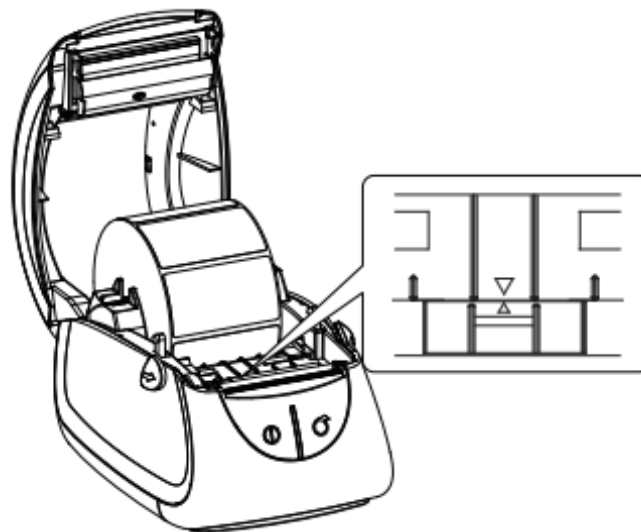

### 3.5 Operation Panel

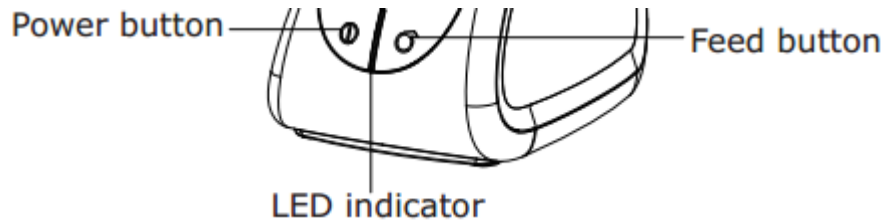

#### ■ POWER Button

This button is used to turn the printer on/off.

When the printer is off, keep pressing  button about 1.25 second, the printer is on and the LED indicator is blue. The printer work normally, the LED indicator is green. When paper out or abnormal working, the LED indicator is red.



#### ■ FEED Button



This button is used to feed paper manually, take the self-test.

- 1) To feed paper manually, press this button.
- 2) For information on the self-test, refer to Print Self-test Page”.

#### ■ Settings mode

1) Finish the following two steps within 2 seconds after power on will put the printer into Setting Mode.

- ① Press  button three times;
- ② press  button one time .

2) In setting mode, press  button to switch the setting item, press  button to confirm the change and enter to next setting item.

#### LED indicators:

LED Indicators		Remarks
Color	Status	
BLUE	ON	The printer is ready to print with label media
Green	ON	The paper is feeding/under printing
RED	ON	The printer cover button is not in right position
YELLOW	ON	The printer is ready to print with continuous media
PINK	ON	The thermal printer head is overheated
BLUE	FLASH	Do not pass the RAM test
RED	FLASH	Out of paper
WHITE	ON	The printer is ready to print with black mark media

## 3.6 Basic Operation

### 3.6.1 Power On/Power Off

Press "-" at the rear turn on the power switch, the printer is on and LED indicator is blue.  
Press "O" at the rear turn off the power switch, the printer is off and LED indicator is off.

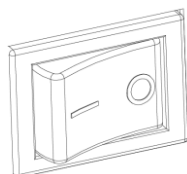

### 3.6.2 Feed

When the printer is on, press feed button, printer will automatically feed paper to the specified position according to the paper type you use. Press feed button, printer will feed a fixed distance paper under "Continuous Mode"; printer will feed a whole label under "Label Mode".

### 3.6.3 Print Self-test Page

The self-test checks whether the printer has any problems.

The method of self-test:

#### Print Self-test Page Manually

1. Make sure paper is loading properly.
2. Make sure the printer is off and top cover closes properly.
3. Press the FEED button and turns the printer on simultaneously, the printer prints self-test page.

#### Printing Windows Driver Program

1. Install the Windows driver. Refer to the **Windows Driver Installation** for the installation procedure.
2. Please set the "Interface" as the type you use.
3. Print the test page using the "Print test page" function of Windows driver.

# Chapter 4 Interface

## 4.1 USB interface

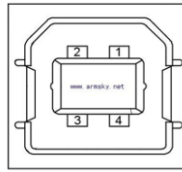

Figure 4-1

PIN No.	Signal name
1	VBUS
2	D-
3	D+
4	GND

## 4.2 Cashdrawer



Pin No.	Signal	Function
1	FG	Frame Ground
2	DRAWER1	Drawer kick-out drive signal 1
3	DRSW	Drawer open/close signal
4	VDR	Drawer driving source
5	DRAWER2	Drawer kick-out drive signal 2
6	GND	GND

Voltage:12V DC

Current:2A max.

Signal: “L” = 0~0.5 V ; “H” = 2.4~3.3 V

### 4.3 Serial Interface

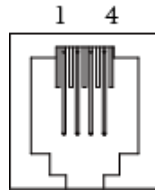

PIN No.	Signal name
1	RTS
2	RXD
3	GND
4	TXD

## Chapter 5 Cleaning

Adhesives and coatings of the media can transfer onto the printer parts over time along the media path including the thermal print head and media sensor. This build-up can accumulate dust and debris. Failure to clean the print head, media path, and media sensor could result in print quality, worst more of inadvertent loss off labels, label jams and possible damage to the printer.

### ※ CAUTION

- Make sure to turn the printer off prior to cleaning.
- As the print head gets very hot during printing, if intending to clean the print head, turn the printer off and wait approximately 2~3 minute before commencement.
- When cleaning the print head, take care not to touch the heated portion of the print head.  
→ Printer Head is susceptible to damage from static electricity, etc.
- Take care not to allow the print head to become scratched and/or damaged in any way.

### 5.1 Cleaning Media Sensor

Debris or dirt on the paper sensor can cause a miss-read or unstable detection of the label gap. Clean with a cotton bud dampened with alcohol.

### 5.2 Cleaning Thermal Print Head

Thermal Paper stock on the print head, which degrades print quality. Clean the print head with methanol or isopropyl alcohol and a cotton bud. Do not touch the heating elements with your fingers.

- 1) Open the Printer Cover and then use the cleaning pen to clean the head in the direction from the center of the head to two sides.
- 2) After cleaning the head, do not use the printer until the alcohol used for cleaning evaporates completely (1~2 min) and the printer has completely dried.

※ Perform the cleaning process each time the paper roll is replaced to prevent print quality deterioration.

### 5.3 Cleaning Roller and/or Paper Path

- 1) Open the printer cover and then remove the paper.
- 2) Remove any dust or foreign substance using dry cloth or cotton swab.
- 3) Soak the cloth or cotton swab in alcohol for medical use and use it to remove adhesive foreign substances or other pollution materials.
- 4) After cleaning the parts, do not use the printer until the alcohol evaporates completely (1~2 min) and the printer has completely dried

※ Clean the parts when there is a degradation of print quality or paper detection.



# Chapter 6 Label Printer Utility Instructions

## 6.1 Installation Preparation

Download HPRTUtilityForLabel application program. Latest version please see our website.

## 6.2 Usage

**Note:** The screen may vary slightly by different operating systems and models. Following takes LPQ80 (Windows XP) for example.

(1).Install “HPRTUtilityForLabel V2.0.0.1.exe” and then open the “HPRTUtilityForLabel”.

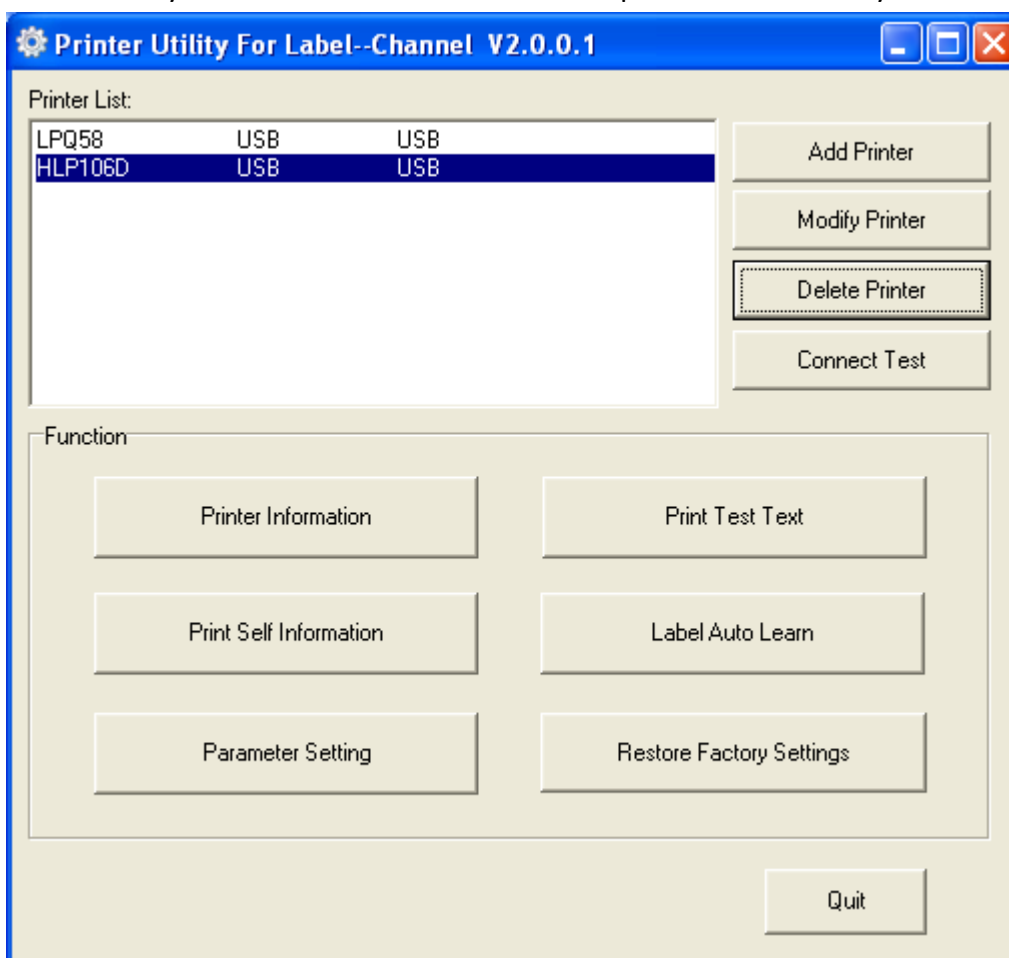

(2).Add/Modify/Delete Printer, Connect Test.

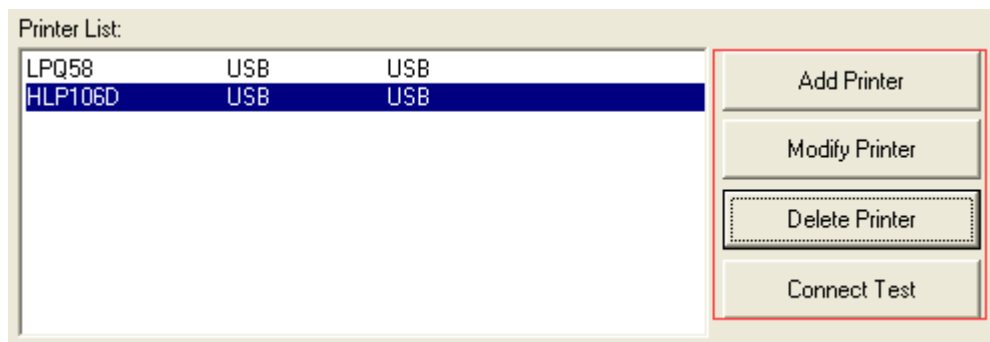

- Click “Add Printer” choose the printer and port(take USB for example), click “OK” add successful, check in “Printer List”.

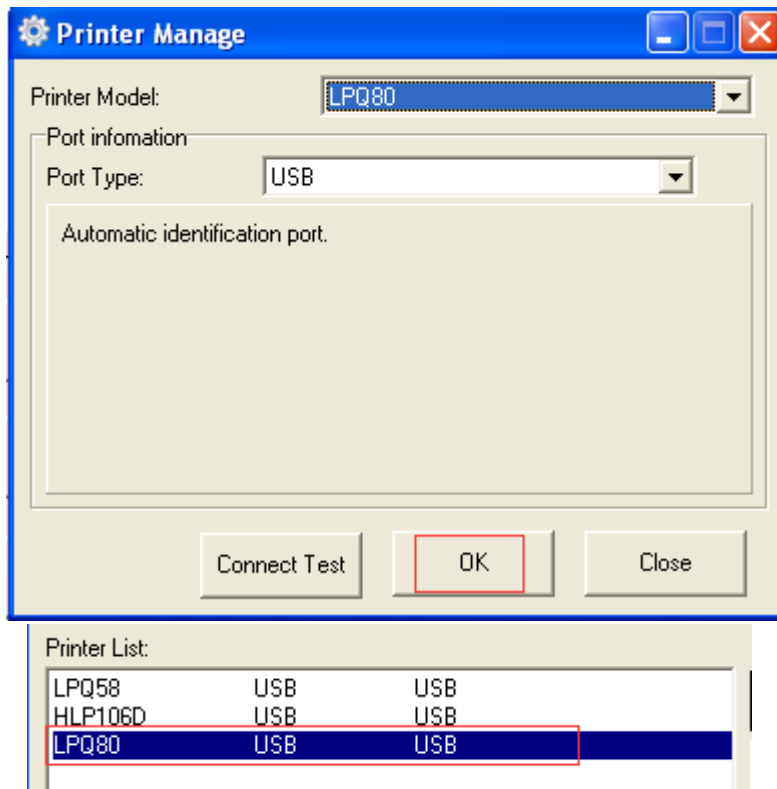

- Click “Modify Printer” choose the printer and port(take COM1 for example), click “OK” modify successful, check in “Printer List” .

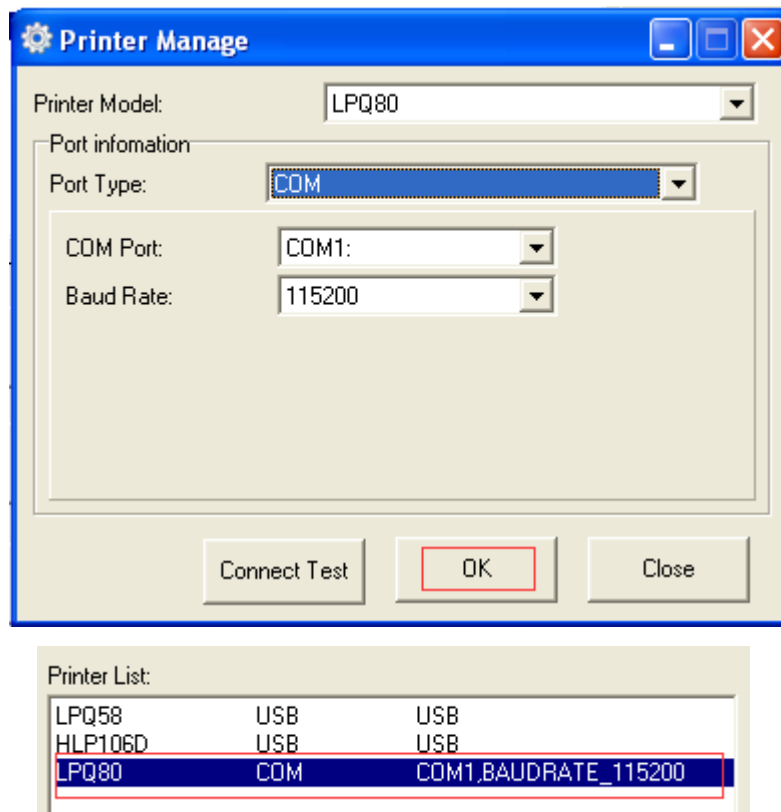

- Click “Delete Printer”, click “OK” delete the printer you chosen, click “Cancel” cancel delete printer.

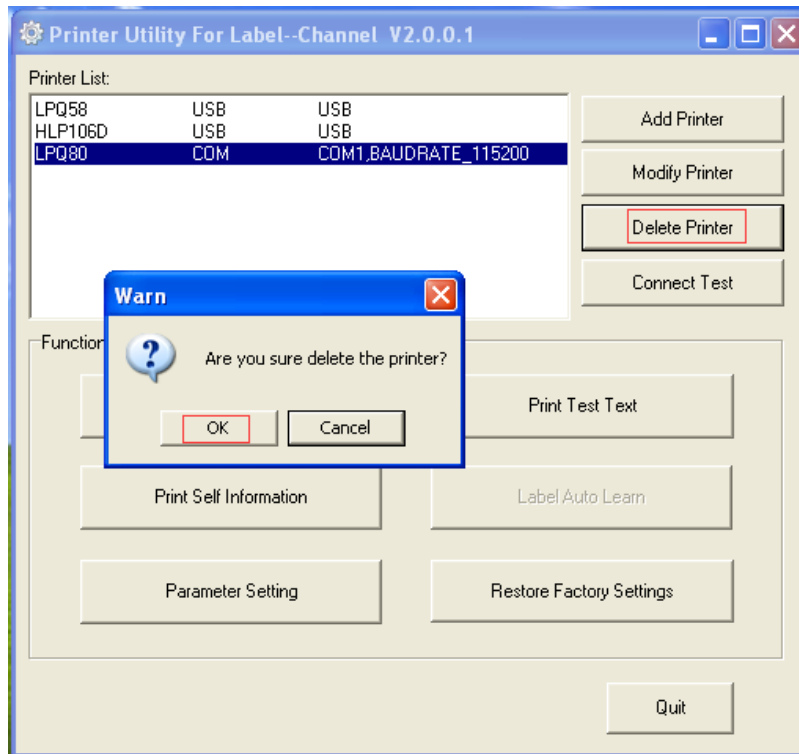

- Choose the printer you currently use, connect it with computer; Click “Connect Test” to test whether the connection is ok or not.  
If connection is OK, the icon below will come out.

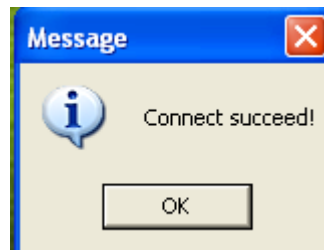

If connection fails, normally shows following icon.

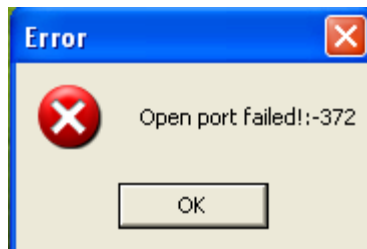

**Note:** Please connect your printer to power first, choose one port (depend on the printer you bought) to connecting to the PC. Connecting method see more information in Power Connection.

**When connection fail, please check the connection or whether the port matches.(When USB port is used, it is better to make sure only one printer is connected)**

(3).Function.

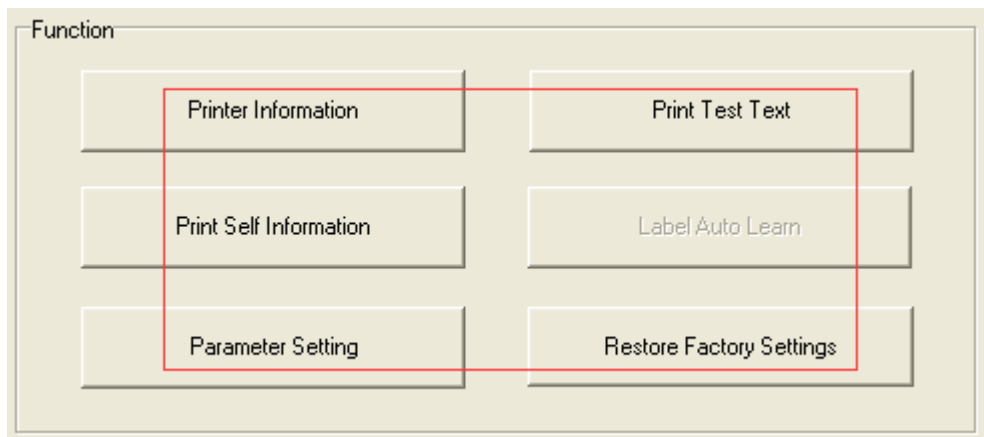

- Click “Printer Information”, shows printer information.(Differ from your printer)

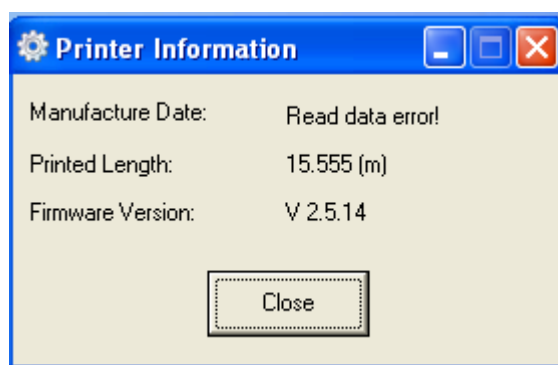

- Click “Print Self Information”, printer print out self-test page.

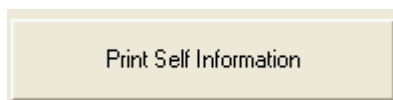

- Click “Print Test Text”, type the text you need to print→ Set up the printing range(printable width & height)→Click “Print” printer start to print printer test text.

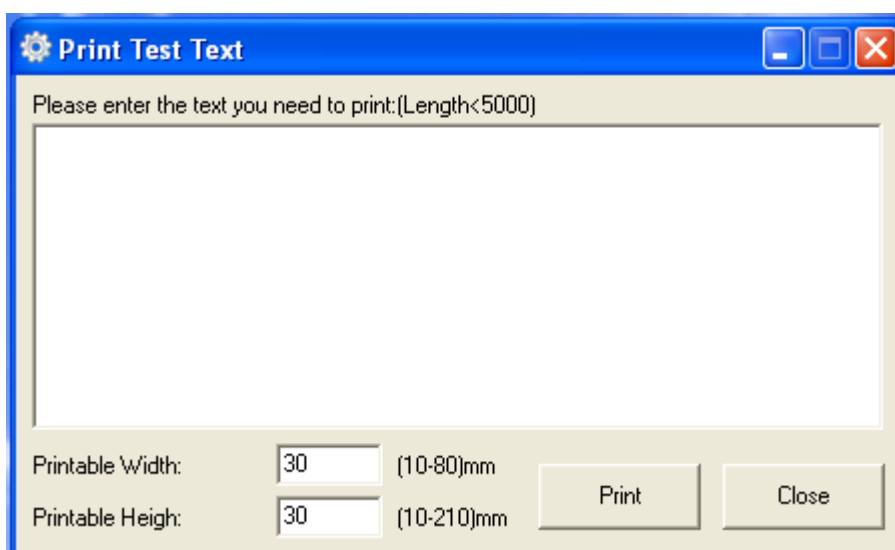

- Click “Parameter Setting”.

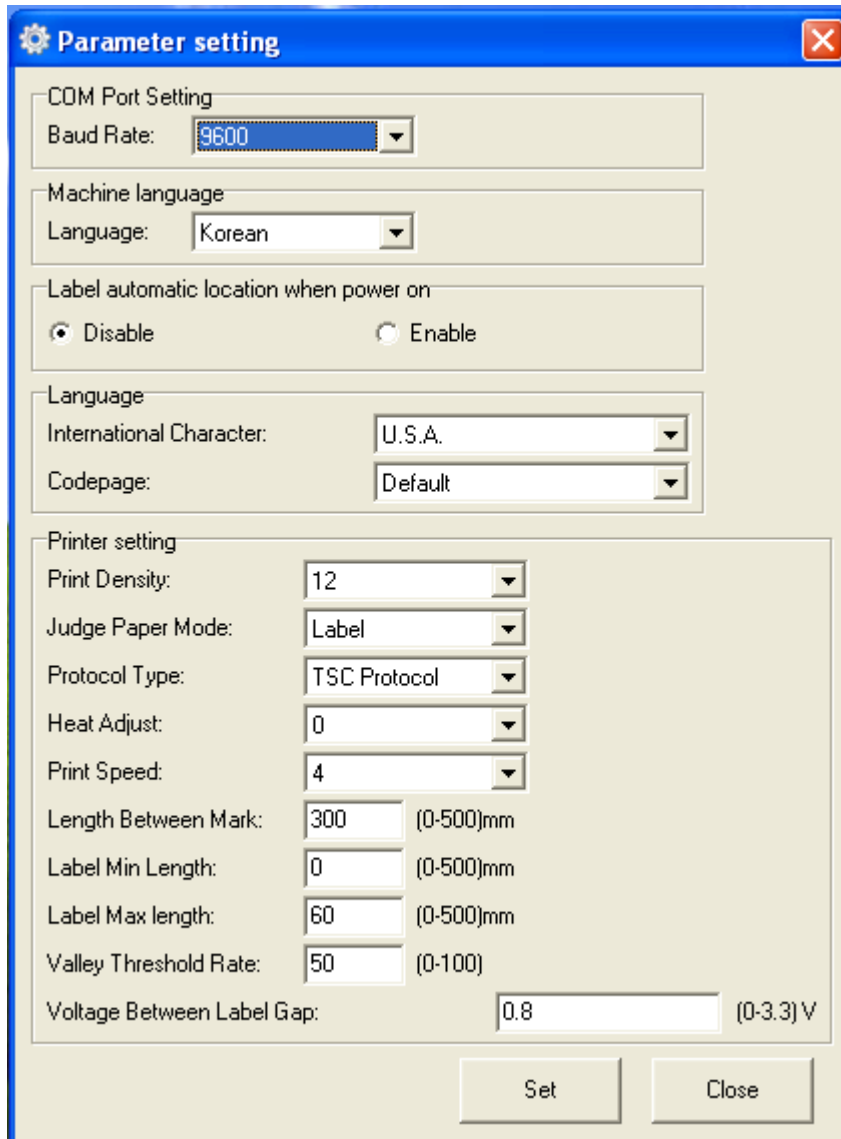

1) COM Port Setting:

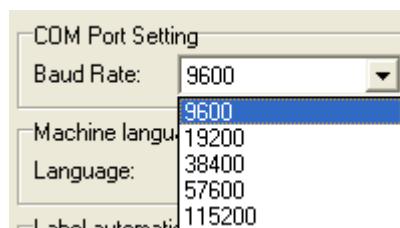

2)Machine language:

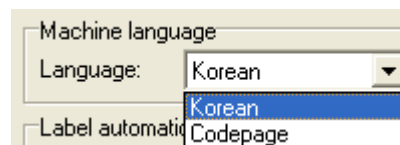

3)Label paper automatic position when power on:

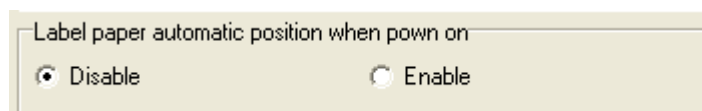

4)Language:

Language  
 International Character: U.S.A.  
 Codepage: PC866(Cyrillic #2)

5)Printer setting:

Printer setting  
 Print Density: 12  
 Judge Paper Mode: Label  
 Protocol Type: TSC Protocol  
 Heat Adjust: 0  
 Print Speed: 4  
 Length Between Mark: 300 (0-500)mm  
 Label Min Length: 0 (0-500)mm  
 Label Max length: 60 (0-500)mm  
 Valley Threshold Rate: 50 (0-100)  
 Voltage Between Label Gap: 0.8 (0-3.3) V

▪Print Density(choose range:0~15):

Print Density: 2

▪Judge Paper Mode(choose range: Label,Receipt,BlackMark):

Judge Paper Mode: Label

▪ Protocal Type:

Protocol Type: TSC Protocol

▪Heat Adjust:

Heat Adjust: -50  
 Print Speed: -50  
 Length Between Mark: -45  
 Label Min Length: -40  
 Label Max length: -35  
 Valley Threshold Rate: -30  
 -25  
 -20  
 -15

▪Print Speed(choose range:2,3,4)vary by models:

Print Speed: 2

- Length Between Mark(choose range:0~500mm):

Length Between Mark:  (0-500mm)

- Label Min Length(choose range:0~500mm):

Label Min Length:  (0-500mm)

- Label Max Length(choose range:0~500mm):

Label Max length:  (0-500mm)

- Valley Threshold Rate(choose range:0~100):

Valley Threshold Rate:  (0-100)

- Voltage Between Label Gap(choose range:0~3.3V):

Voltage Between Label Gap:  (0-3.3) V

9)Click “Set” save all the above settings, click “ok” back to the main menu.

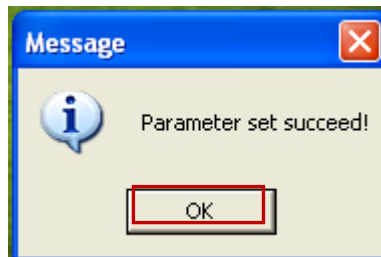

Click “Close” all the settings canceled and back to the main menu.

- Click “Restore Factory Settings”, click “OK” printer restore factory settings, click “Cancel” cancel restore factory settings.

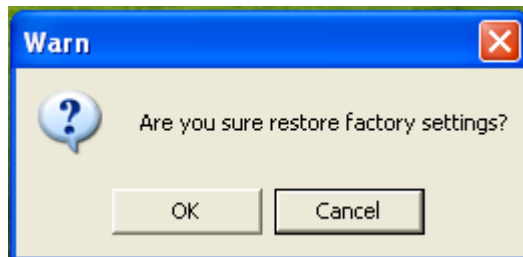

(4).Click “Quit”, finish printer settings.

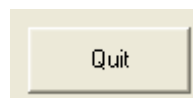

# Chapter 7 Seagull Windows Driver Installation

## 7.1 Introduction

This chapter provides information on installation according to PC operating system (OS).

This driver support for these following operating systems:

- Microsoft Windows 10 (32 bit/64 bit)
- Microsoft Windows 8 (32 bit/64 bit)
- Microsoft Windows 7 SPI (32 bit/64 bit)
- Microsoft Windows Vista SP2 (32 bit/64 bit)
- Microsoft Windows XP Professional SP3 (32 bit)
- Microsoft Windows Server 2012(64 bit)
- Microsoft Windows Server 2008 R2
- Microsoft Windows Server 2008 SP2(32 bit/64 bit)
- Microsoft Windows Server 2003 R2 SP2(32 bit/64 bit)

## 7.2 Installation Preparation

Download Seagull Windows Driver application program. Latest version please see our website.



## 7.3 Installation

**Note:** Under different operating systems, the screen has slight difference. Please operate it according to the tips. Take HPRT LPQ80(Windows XP) for example. Recommend to close security software before installation in case of preventing installation.

1. Select one interface to connect your printer to computer.
2. Turn on the printer check if it successfully connected to computer.

3. Double click Seagull Windows Driver .

4. After agree to the EULA, click "Next".

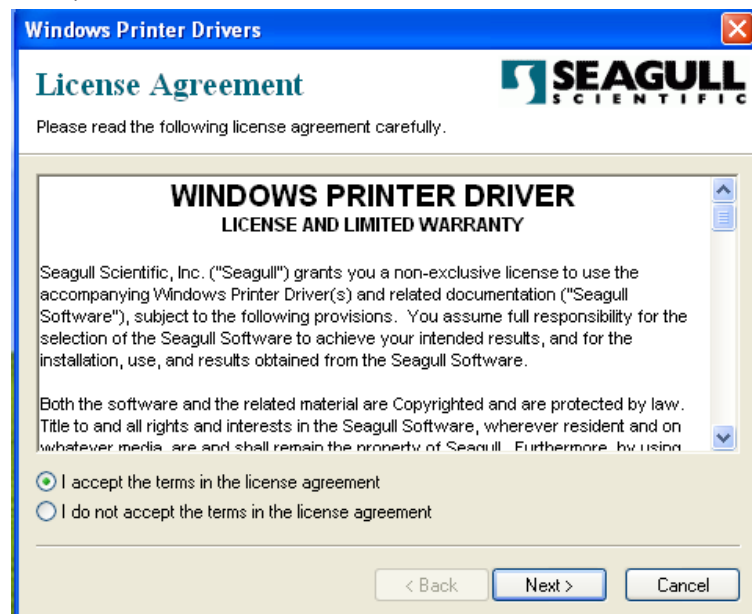

5. Select a directory on the computer to unpack the driver or accept the default location then click "Next".

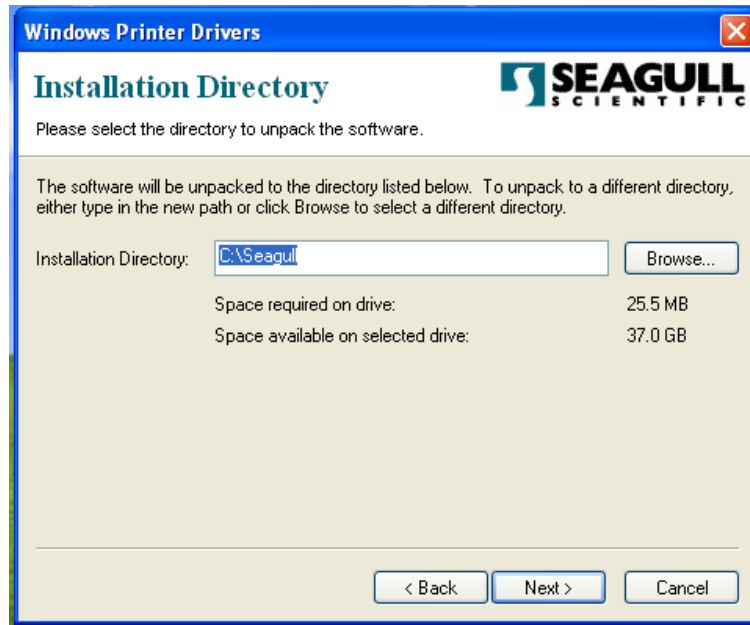

6. Click "Finish".

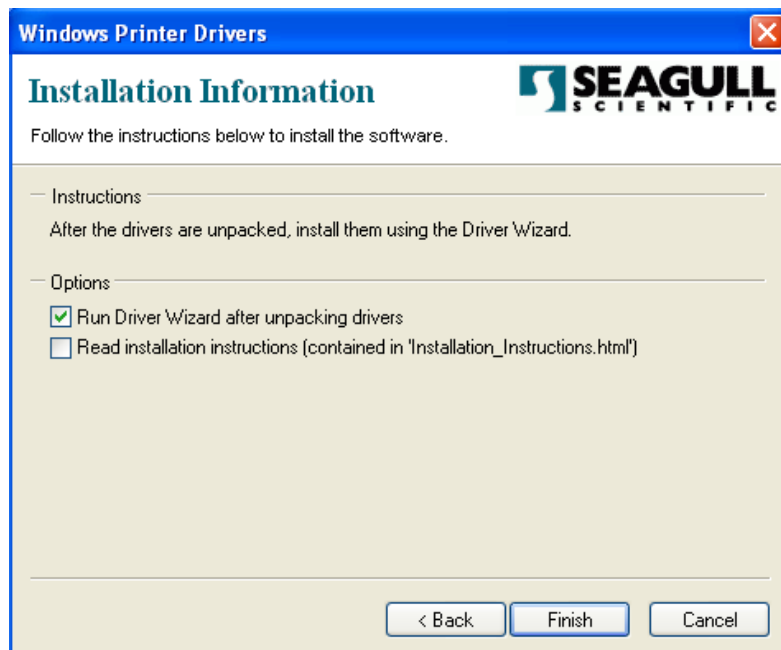

7. Select "Install printer drivers" then click "Next".



**Note:** Connect your printer to computer, can automatically detect and install. (Take USB for example)

8. Select "Install a driver for a Plug and Play printer, click "Next".

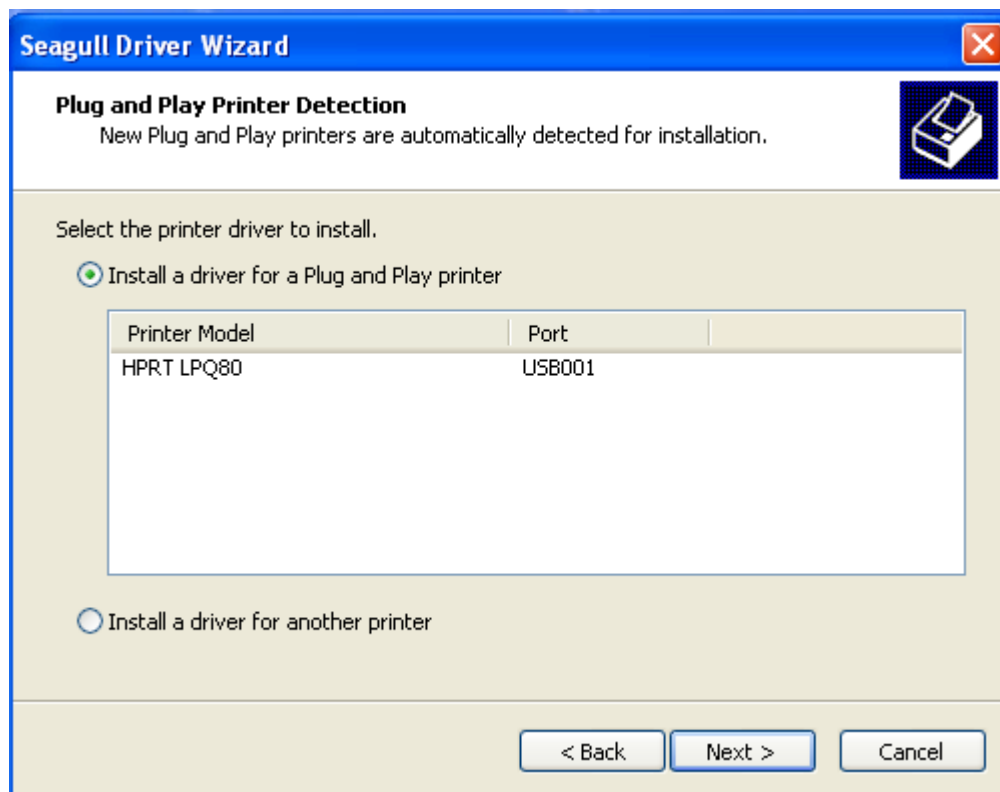

9. Enter a name for this printer, click "Next".

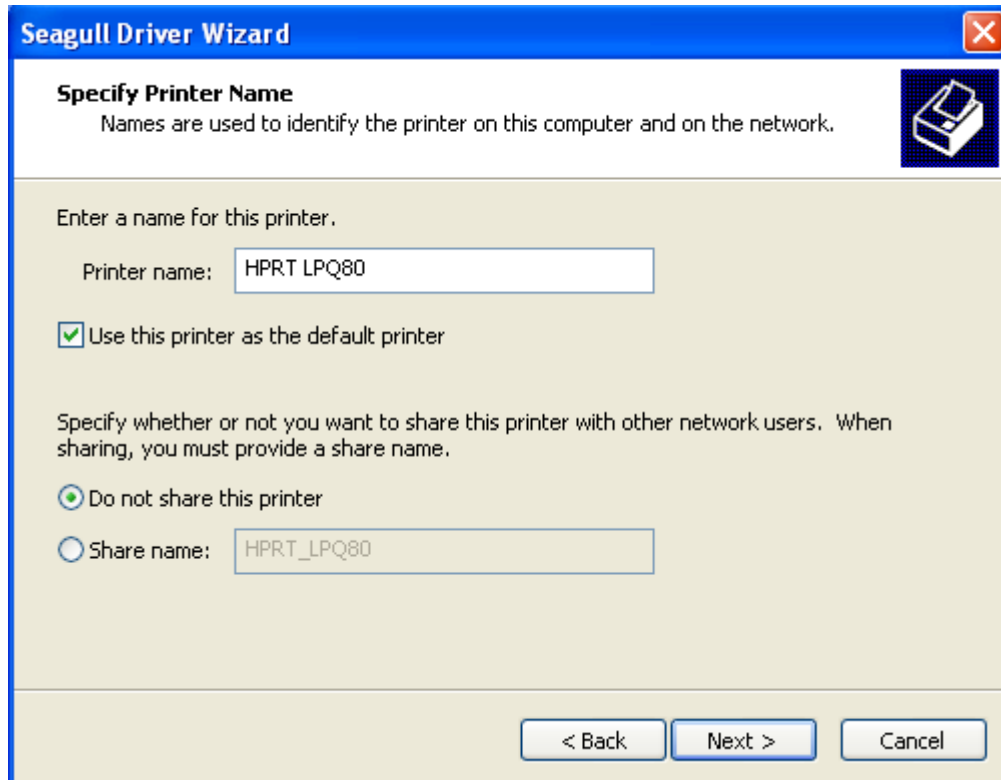

10. Click "Finish".

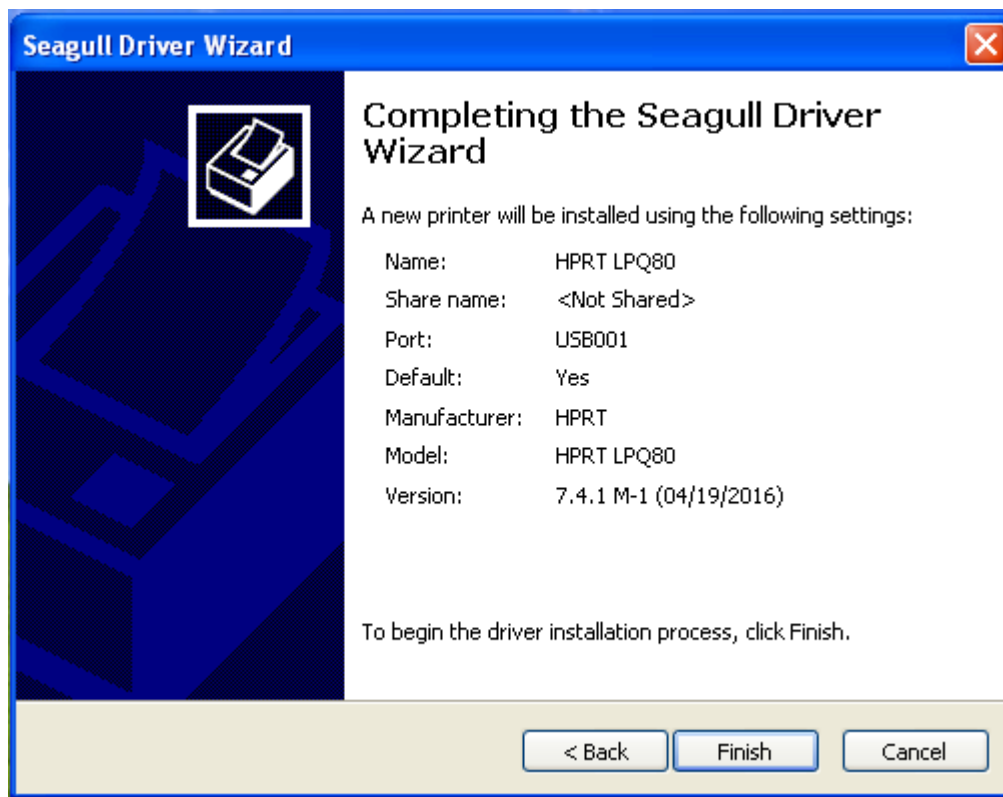

11. Click "Close", the HPRT LPQ80 Label printer driver installed successfully.

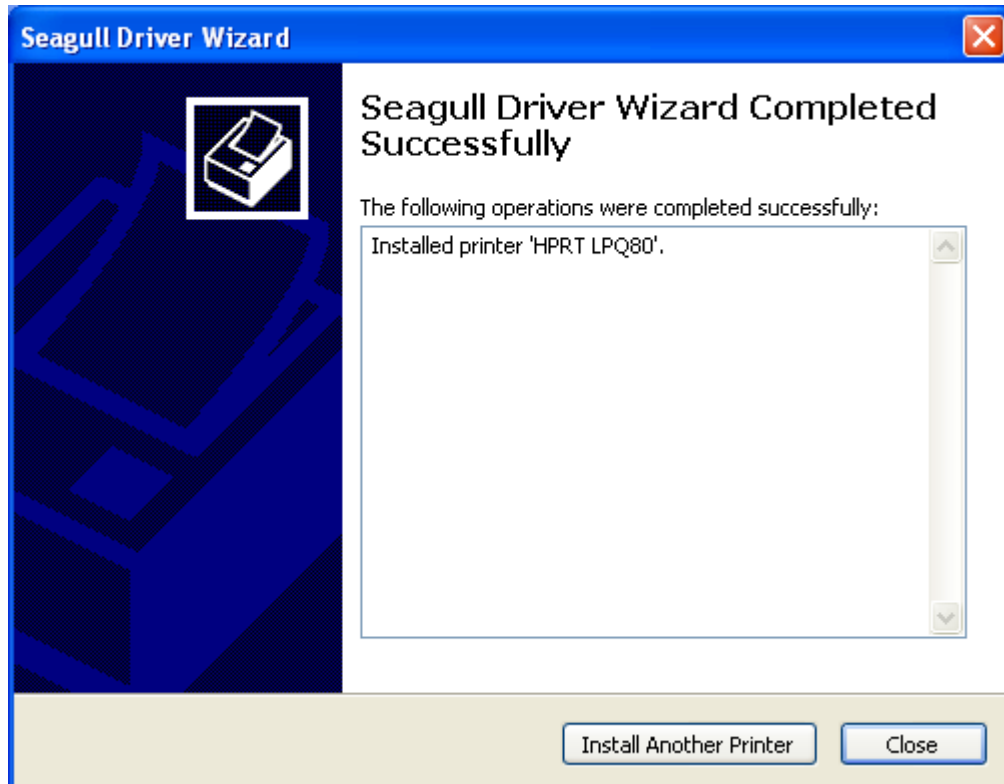

12. After installation, the icon will be found in "Start" → "Printers and Faxes".

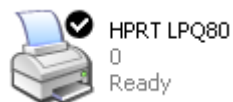

**Note:**

- 1. If you already installed the driver (No matter what kind of port), when you connect the printer with computer, it will create a USB port automatically.**
- 2. Any problems please use our utility in the CD.**

# Chapter 8 BarTender® Ultralite Installation

## 8.1 Introduction

This chapter provides information on BarTender® installation according to PC operating systems(OS).

This label design software is available in two versions:32-bit and 64-bit.

## 8.2 Installation Preparation

Download BarTender® application program.

## 8.3 Installation



**Note :** Under different operating system, the screen has slight difference. Please operate it according to the tips. Take Windows 7 for example.(Recommend to close security software before installation in case of preventing installation)

1. Double click application program .
2. Select language, then click "OK".

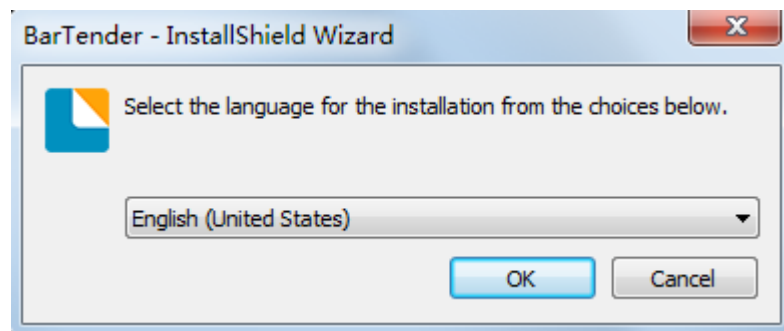

3. Click "Next".

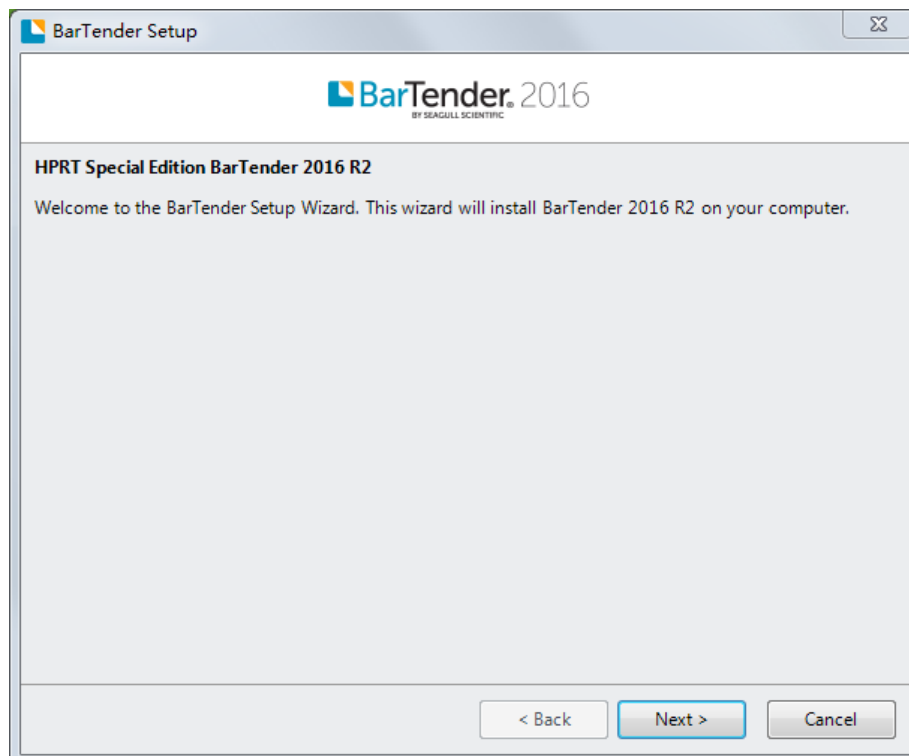

4. Read and accept the license agreement, then click "Next".

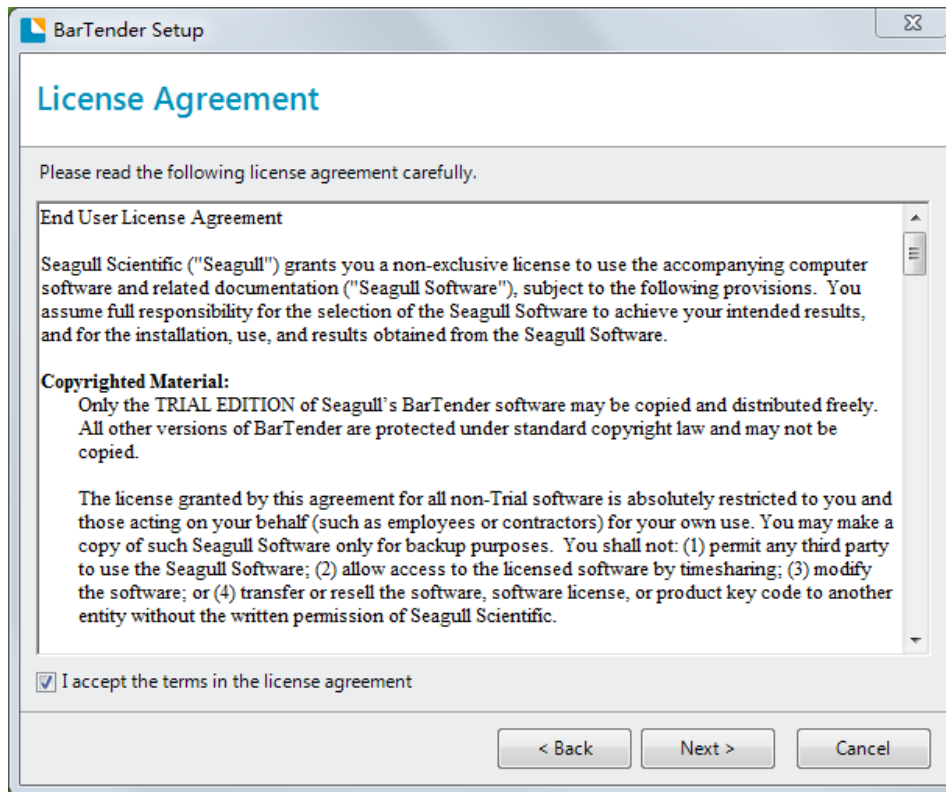

5. Select "Features" and "Installation Location" then click "Next".

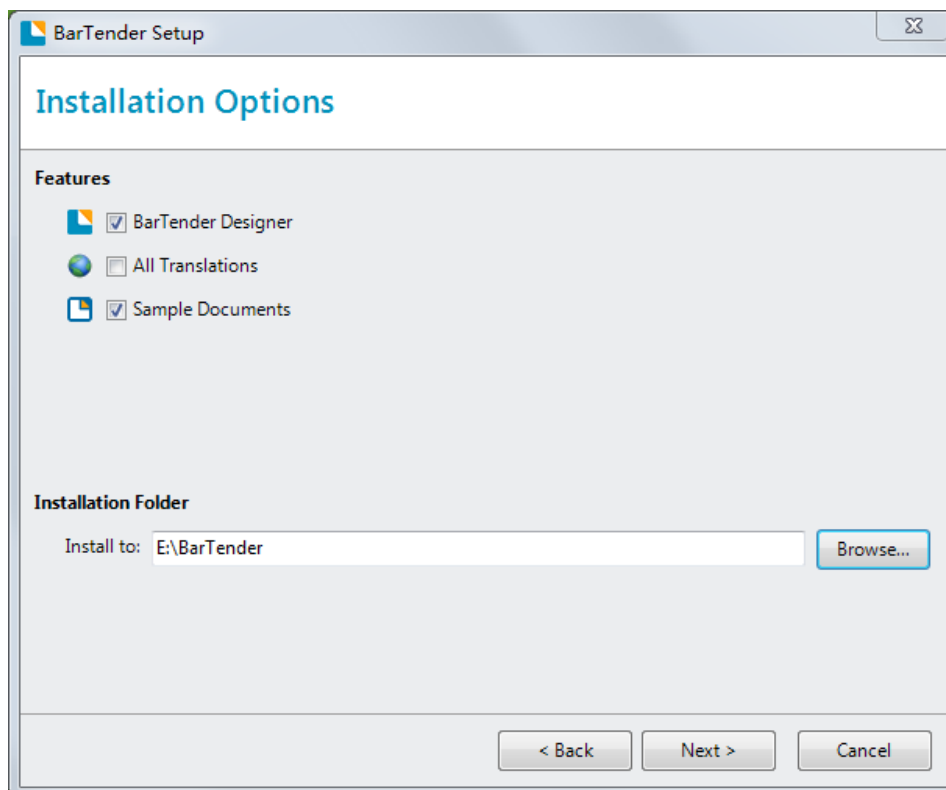



6. Click "Installation".

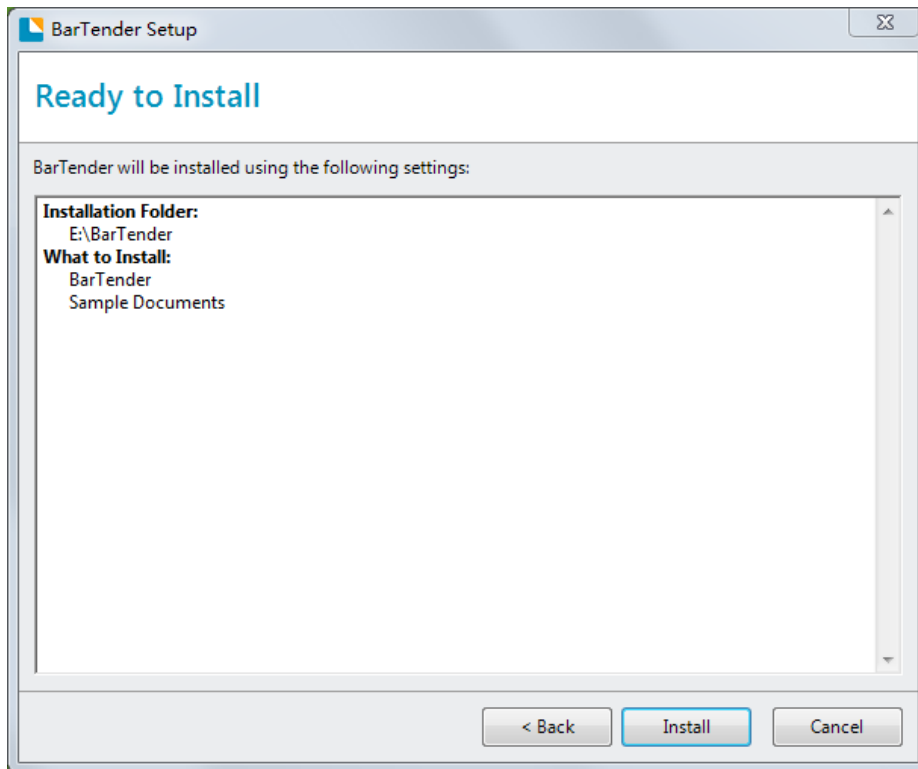

7. If occurs following windows, please choose "Allow this operation", or you may close security software before installation in case of preventing installation.



8. Click "Finish".

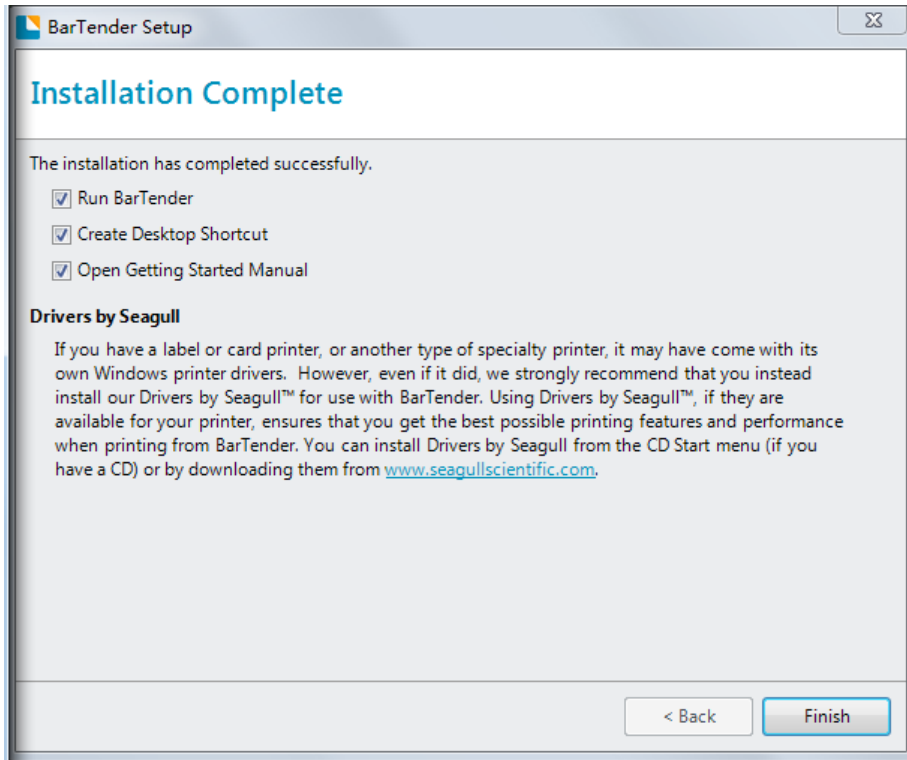

9. Select the edition you need ( can be changed according to your need while using ) ,then click "OK".

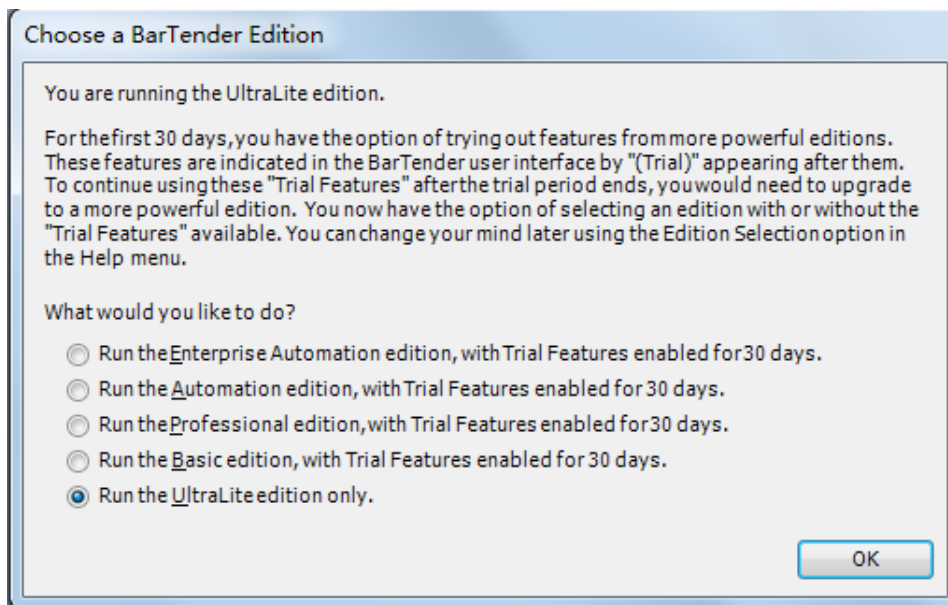

10. Click "Close", BarTender® installed successfully.

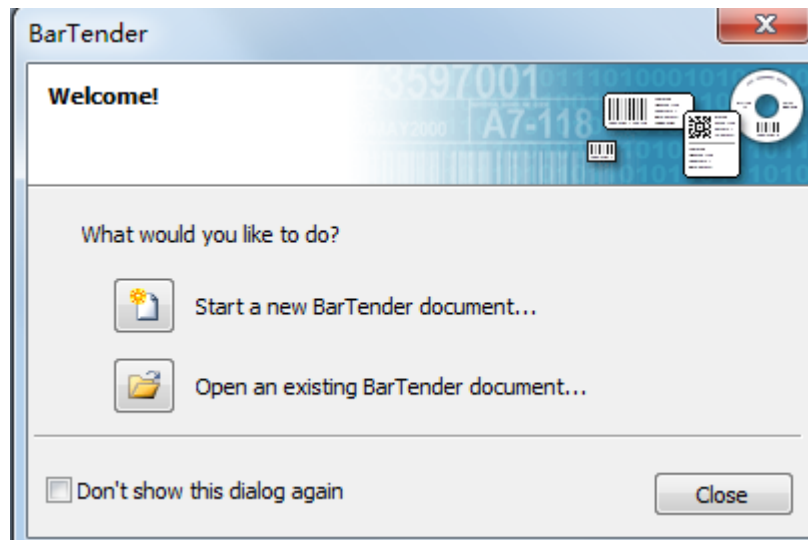

11. Back to desktop, you may see BarTender® icon, double click it get down to use.

